

FEATURES

- 1 ppm resolution
- 1 ppm INL
- 7.5 nV/ $\sqrt{\text{Hz}}$ noise spectral density
- 0.19 LSB long-term linearity stability
- <0.05 ppm/ $^{\circ}\text{C}$ temperature drift
- 1 μs settling time
- 1.4 nV-sec glitch impulse
- 20-lead TSSOP package
- Wide power supply range up to $\pm 16.5\text{ V}$
- 35 MHz Schmitt triggered digital interface
- 1.8 V compatible digital interface
- Extended automotive operating temperature range: -55°C
to $+125^{\circ}\text{C}$

ENHANCED PRODUCT FEATURES

- Supports defense and aerospace applications (AQEC standard)
- Military temperature range (-55°C to $+125^{\circ}\text{C}$)
- Controlled manufacturing baseline
- One assembly/test site
- One fabrication site
- Enhanced product change notification
- Qualification data available on request

APPLICATIONS

- Medical instrumentation
- Test and measurement
- Industrial control
- High end scientific and aerospace instrumentation

GENERAL DESCRIPTION

The **AD5791-EP**¹ is a single 20-bit, unbuffered voltage-output DAC that operates from a bipolar supply of up to 33 V. The AD5791 accepts a positive reference input in the range 5 V to $V_{\text{DD}} - 2.5\text{ V}$ and a negative reference input in the range $V_{\text{SS}} + 2.5\text{ V}$ to 0 V. The **AD5791-EP** offers a relative accuracy specification of $\pm 1\text{ LSB}$ max, and operation is guaranteed monotonic with a $\pm 1\text{ LSB}$ DNL maximum specification.

The part uses a versatile 3-wire serial interface that operates at clock rates up to 35 MHz and that is compatible with standard SPI, QSPI™, MICROWIRE™, and DSP interface standards. The part incorporates a power-on reset circuit that ensures the DAC output powers up to 0 V in a known output impedance state and remains in this state until a valid write to the device takes

¹ Protected by U.S. Patents No. 7,884,747 and 8,089,380. Other patents pending.

Rev. 0

Information furnished by Analog Devices is believed to be accurate and reliable. However, no responsibility is assumed by Analog Devices for its use, nor for any infringements of patents or other rights of third parties that may result from its use. Specifications subject to change without notice. No license is granted by implication or otherwise under any patent or patent rights of Analog Devices. Trademarks and registered trademarks are the property of their respective owners.

FUNCTIONAL BLOCK DIAGRAM

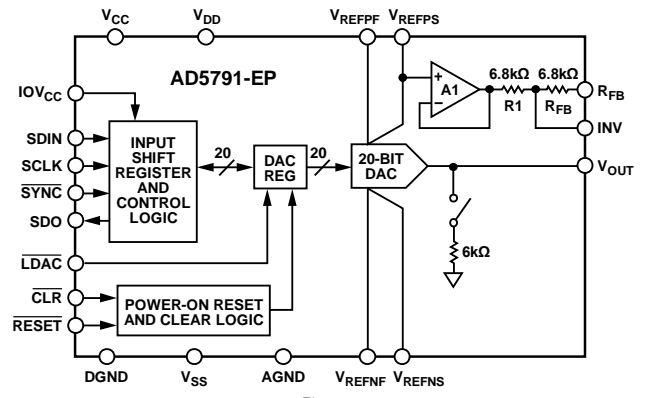

Figure 1.

COMPANION PRODUCTS

Ultra precision op amps: **AD8675**, **AD8676**

High voltage op amp: **ADA4898-1**

Additional companion products on the [AD5791 product page](#)

Table 1. Related Device

Part No.	Description
AD5781	18-bit, 0.5 LSB INL, voltage output DAC

place. The part provides an output clamp feature that places the output in a defined load state.

The **AD5791-EP** is available in a compact, 20-lead TSSOP package and operates at the extended automotive temperature range of -55°C to $+125^{\circ}\text{C}$. Additional application and technical information can be found in the [AD5791](#) data sheet.

PRODUCT HIGHLIGHTS

1. 1 ppm Accuracy.
2. Wide Power Supply Range up to $\pm 16.5\text{ V}$.
3. Operating Temperature Range: -55°C to $+125^{\circ}\text{C}$.
4. Low 7.5 nV/ $\sqrt{\text{Hz}}$ Noise Spectral Density.
5. Low 0.05 ppm/ $^{\circ}\text{C}$ Temperature Drift.

TABLE OF CONTENTS

Features	1	Specifications	3
Enhanced Product Features	1	Timing Characteristics	5
Applications.....	1	Absolute Maximum Ratings	8
Functional Block Diagram	1	ESD Caution.....	8
Companion Products	1	Pin Configuration and Function Descriptions.....	9
General Description	1	Typical Performance Characteristics	10
Product Highlights	1	Outline Dimensions	18
Revision History	2	Ordering Guide	18

REVISION HISTORY

2/12—Revision 0: Initial Version

SPECIFICATIONS

$V_{DD} = 12.5\text{ V to }16.5\text{ V}$, $V_{SS} = -16.5\text{ V to }-12.5\text{ V}$, $V_{REFP} = 10\text{ V}$, $V_{REFN} = -10\text{ V}$, $V_{CC} = 2.7\text{ V to }+5.5\text{ V}$, $IOV_{CC} = 1.71\text{ V to }5.5\text{ V}$, $R_L = \text{unloaded}$, $C_L = \text{unloaded}$, all specifications T_{MIN} to T_{MAX} , unless otherwise noted.

Table 2.

Parameter ¹	Min	Typ	Max	Unit	Test Conditions/Comments
STATIC PERFORMANCE²					
Resolution	20			Bits	
Integral Nonlinearity Error (Relative Accuracy)	-1	±0.25	+1	LSB	$V_{REFP} = +10\text{ V}$, $V_{REFN} = -10\text{ V}$, $T_A = 0^\circ\text{C to }105^\circ\text{C}$
	-1.5	±0.25	+1.5	LSB	$V_{REFP} = +10\text{ V}$, $V_{REFN} = -10\text{ V}$
	-1.5	±0.5	+1.5	LSB	$V_{REFP} = 10\text{ V}$, $V_{REFN} = 0\text{ V}^3$
	-3	±1	+3	LSB	$V_{REFP} = 5\text{ V}$, $V_{REFN} = 0\text{ V}^3$
Differential Nonlinearity Error	-1	±0.5	+1	LSB	$V_{REFP} = +10\text{ V}$, $V_{REFN} = -10\text{ V}$
	-1.5	±0.75	+1.5	LSB	$V_{REFP} = 10\text{ V}$, $V_{REFN} = 0\text{ V}$
	-2.5	±1	+2.5	LSB	$V_{REFP} = 5\text{ V}$, $V_{REFN} = 0\text{ V}$
Linearity Error Long-Term Stability ⁴		0.16		LSB	After 500 hours at $T_A = 125^\circ\text{C}$
		0.19		LSB	After 1000 hours at $T_A = 125^\circ\text{C}$
		0.11		LSB	After 1000 hours at $T_A = 100^\circ\text{C}$
Full-Scale Error	-7	±0.1	+7	LSB	$V_{REFP} = +10\text{ V}$, $V_{REFN} = -10\text{ V}^3$
	-11	±0.25	+11	LSB	$V_{REFP} = 10\text{ V}$, $V_{REFN} = 0\text{ V}^3$
	-21	±0.8	+21	LSB	$V_{REFP} = 5\text{ V}$, $V_{REFN} = 0\text{ V}^3$
	-4	±0.1	+4	LSB	$V_{REFP} = +10\text{ V}$, $V_{REFN} = -10\text{ V}^3$, $T_A = 0^\circ\text{C to }105^\circ\text{C}$
	-4	±0.25	+4	LSB	$V_{REFP} = 10\text{ V}$, $V_{REFN} = 0\text{ V}^3$, $T_A = 0^\circ\text{C to }105^\circ\text{C}$
	-6	±0.8	+6	LSB	$V_{REFP} = 5\text{ V}$, $V_{REFN} = 0\text{ V}^3$, $T_A = 0^\circ\text{C to }105^\circ\text{C}$
Full-Scale Error Temperature Coefficient		±0.02		ppm FSR/ $^\circ\text{C}$	
Zero-Scale Error	-7	±0.1	+7	LSB	$V_{REFP} = +10\text{ V}$, $V_{REFN} = -10\text{ V}^3$
	-10	±0.15	+10	LSB	$V_{REFP} = 10\text{ V}$, $V_{REFN} = 0\text{ V}^3$
	-21	±0.75	+21	LSB	$V_{REFP} = 5\text{ V}$, $V_{REFN} = 0\text{ V}^3$
	-4	±0.1	+4	LSB	$V_{REFP} = +10\text{ V}$, $V_{REFN} = -10\text{ V}^3$, $T_A = 0^\circ\text{C to }105^\circ\text{C}$
	-4	±0.15	+4	LSB	$V_{REFP} = 10\text{ V}$, $V_{REFN} = 0\text{ V}^3$, $T_A = 0^\circ\text{C to }105^\circ\text{C}$
	-6	±0.75	+6	LSB	$V_{REFP} = 5\text{ V}$, $V_{REFN} = 0\text{ V}^3$, $T_A = 0^\circ\text{C to }105^\circ\text{C}$
Zero-Scale Error Temperature Coefficient ³		±0.04		ppm FSR/ $^\circ\text{C}$	
Gain Error	-6	±0.3	+6	ppm FSR	$V_{REFP} = +10\text{ V}$, $V_{REFN} = -10\text{ V}^3$
	-10	±0.4	+10	ppm FSR	$V_{REFP} = 10\text{ V}$, $V_{REFN} = 0\text{ V}^3$
	-20	±0.4	+20	ppm FSR	$V_{REFP} = 5\text{ V}$, $V_{REFN} = 0\text{ V}^3$
	-6	±0.3	+6	ppm FSR	$V_{REFP} = +10\text{ V}$, $V_{REFN} = -10\text{ V}^3$, $T_A = 0^\circ\text{C to }105^\circ\text{C}$
	-6	±0.4	+6	ppm FSR	$V_{REFP} = 10\text{ V}$, $V_{REFN} = 0\text{ V}^3$, $T_A = 0^\circ\text{C to }105^\circ\text{C}$
	-7	±0.4	+7	ppm FSR	$V_{REFP} = 5\text{ V}$, $V_{REFN} = 0\text{ V}^3$, $T_A = 0^\circ\text{C to }105^\circ\text{C}$
Gain Error Temperature Coefficient ³		±0.04		ppm FSR/ $^\circ\text{C}$	
R_1 , R_{FB} Matching		0.01		%	
OUTPUT CHARACTERISTICS³					
Output Voltage Range	V_{REFN}		V_{REFP}	V	
Output Slew Rate		50		V/ μs	
Output Voltage Settling Time		1		μs	10 V step to 0.02%, using the AD845 buffer in unity-gain mode
Output Noise Spectral Density		1		μs	500 code step to $\pm 1\text{ LSB}^5$
		7.5		nV/ $\sqrt{\text{Hz}}$	at 1 kHz, DAC code = midscale
		7.5		nV/ $\sqrt{\text{Hz}}$	at 10 kHz, DAC code = midscale
Output Voltage Noise		7.5		nV/ $\sqrt{\text{Hz}}$	At 100 kHz, DAC code = midscale
		1.1		$\mu\text{V p-p}$	DAC code = midscale, 0.1 Hz to 10 Hz bandwidth ⁶

Parameter ¹	Min	Typ	Max	Unit	Test Conditions/Comments
Midscale Glitch Impulse ⁷		3.1		nV-sec	$V_{REFP} = +10\text{ V}, V_{REFN} = -10\text{ V}$
		1.7		nV-sec	$V_{REFP} = 10\text{ V}, V_{REFN} = 0\text{ V}$
		1.4		nV-sec	$V_{REFP} = 5\text{ V}, V_{REFN} = 0\text{ V}$
MSB Segment Glitch Impulse ⁷		9.1		nV-sec	$V_{REFP} = +10\text{ V}, V_{REFN} = -10\text{ V}$, see Figure 43
		3.6		nV-sec	$V_{REFP} = 10\text{ V}, V_{REFN} = 0\text{ V}$, see Figure 44
		1.9		nV-sec	$V_{REFP} = 5\text{ V}, V_{REFN} = 0\text{ V}$, see Figure 45
Output Enabled Glitch Impulse		45		nV-sec	On removal of output ground clamp
Digital Feedthrough		0.4		nV-sec	
DC Output Impedance (Normal Mode)		3.4		k Ω	
DC Output Impedance (Output Clamped to Ground)		6		k Ω	
Spurious Free Dynamic Range		100		dB	1 kHz tone, 10 kHz sample rate
Total Harmonic Distortion		97		dB	1 kHz tone, 10 kHz sample rate
REFERENCE INPUTS ³					
V_{REFP} Input Range	5		$V_{DD} - 2.5\text{ V}$	V	
V_{REFN} Input Range	$V_{SS} + 2.5\text{ V}$		0	V	
DC Input Impedance	5	6.6		k Ω	V_{REFP}, V_{REFN} , code dependent, typical at midscale code
Input Capacitance		15		pF	V_{REFP}, V_{REFN}
LOGIC INPUTS ³					
Input Current ⁸	-1		+1	μA	
Input Low Voltage, V_{IL}			$0.3 \times IOV_{CC}$	V	$IOV_{CC} = 1.71\text{ V to } 5.5\text{ V}$
Input High Voltage, V_{IH}	$0.7 \times IOV_{CC}$			V	$IOV_{CC} = 1.71\text{ V to } 5.5\text{ V}$
Pin Capacitance		5		pF	
LOGIC OUTPUT (SDO) ³					
Output Low Voltage, V_{OL}			0.4	V	$IOV_{CC} = 1.71\text{ V to } 5.5\text{ V}$, sinking 1 mA
Output High Voltage, V_{OH}	$IOV_{CC} - 0.5\text{ V}$			V	$IOV_{CC} = 1.71\text{ V to } 5.5\text{ V}$, sourcing 1 mA
High Impedance Leakage Current			± 1	μA	
High Impedance Output Capacitance		3		pF	
POWER REQUIREMENTS					All digital inputs at DGND or IOV_{CC}
V_{DD}	7.5		$V_{SS} + 33$	V	
V_{SS}	$V_{DD} - 33$		-2.5	V	
V_{CC}	2.7		5.5	V	
IOV_{CC}	1.71		5.5	V	$IOV_{CC} \leq V_{CC}$
I_{DD}		4.2	5.2	mA	
I_{SS}		4	4.9	mA	
I_{CC}		600	900	μA	
IOI_{CC}		52	140	μA	
DC Power Supply Rejection Ratio ^{3, 9}		± 0.6		$\mu\text{V/V}$	SDO disabled $V_{DD} \pm 10\%$, $V_{SS} = 15\text{ V}$
		± 0.6		$\mu\text{V/V}$	$V_{SS} \pm 10\%$, $V_{DD} = 15\text{ V}$
AC Power Supply Rejection Ratio ³		95		dB	$V_{DD} \pm 200\text{ mV}$, 50 Hz/60 Hz, $V_{SS} = -15\text{ V}$
		95		dB	$\Delta V_{SS} \pm 200\text{ mV}$, 50 Hz/60 Hz, $V_{DD} = 15\text{ V}$

¹ Temperature range: -55°C to $+125^{\circ}\text{C}$, typical at $+25^{\circ}\text{C}$ and $V_{DD} = +15\text{ V}$, $V_{SS} = -15\text{ V}$, $V_{REFP} = +10\text{ V}$, $V_{REFN} = -10\text{ V}$.

² Performance characterized with AD8676BRZ voltage reference buffers and AD8675ARZ output buffer.

³ Guaranteed by design and characterization; not production tested.

⁴ Linearity error refers to both INL error and DNL error, either parameter can be expected to drift by the amount specified after the length of time specified.

⁵ AD5791-EP configured in $\times 2$ gain mode, 25 pF compensation capacitor on AD797.

⁶ Includes noise contribution from AD8676BRZ voltage reference buffers.

⁷ The AD5791-EP is configured in bias compensation mode with a low-pass RC filter on the output. $R = 300\ \Omega$, $C = 143\text{ pF}$ (total capacitance seen by the output buffer, lead capacitance, and so forth).

⁸ Current flowing in an individual logic pin.

⁹ Includes PSRR of AD8676BRZ voltage reference buffers.

TIMING CHARACTERISTICS

$V_{CC} = 2.7\text{ V to }5.5\text{ V}$; all specifications T_{MIN} to T_{MAX} , unless otherwise noted.

Table 3.

Parameter	Limit ¹		Unit	Test Conditions/Comments
	$IOV_{CC} = 1.71\text{ V to }3.3\text{ V}$	$IOV_{CC} = 3.3\text{ V to }5.5\text{ V}$		
t_1^2	40	28	ns min	SCLK cycle time
	92	60	ns min	SCLK cycle time (readback and daisy-chain modes)
t_2	15	10	ns min	SCLK high time
t_3	9	5	ns min	SCLK low time
t_4	5	5	ns min	\overline{SYNC} to SCLK falling edge setup time
t_5	2	2	ns min	SCLK falling edge to \overline{SYNC} rising edge hold time
t_6	48	40	ns min	Minimum \overline{SYNC} high time
t_7	8	6	ns min	\overline{SYNC} rising edge to next SCLK falling edge ignore
t_8	9	7	ns min	Data setup time
t_9	12	7	ns min	Data hold time
t_{10}	13	10	ns min	\overline{LDAC} falling edge to \overline{SYNC} falling edge
t_{11}	20	16	ns min	\overline{SYNC} rising edge to \overline{LDAC} falling edge
t_{12}	14	11	ns min	\overline{LDAC} pulse width low
t_{13}	130	130	ns typ	\overline{LDAC} falling edge to output response time
t_{14}	130	130	ns typ	\overline{SYNC} rising edge to output response time (\overline{LDAC} tied low)
t_{15}	50	50	ns min	\overline{CLR} pulse width low
t_{16}	140	140	ns typ	\overline{CLR} pulse activation time
t_{17}	0	0	ns min	\overline{SYNC} falling edge to first SCLK rising edge
t_{18}	65	60	ns max	\overline{SYNC} rising edge to SDO tristate ($C_L = 50\text{ pF}$)
t_{19}	62	45	ns max	SCLK rising edge to SDO valid ($C_L = 50\text{ pF}$)
t_{20}	0	0	ns min	\overline{SYNC} rising edge to SCLK rising edge ignore
t_{21}	35	35	ns typ	\overline{RESET} pulse width low
t_{22}	150	150	ns typ	\overline{RESET} pulse activation time

¹ All input signals are specified with $t_r = t_f = 1\text{ ns/V}$ (10% to 90% of IOV_{CC}) and timed from a voltage level of $(V_{IL} + V_{IH})/2$.

² Maximum SCLK frequency is 35 MHz for write mode and 16 MHz for readback and daisy-chain modes.

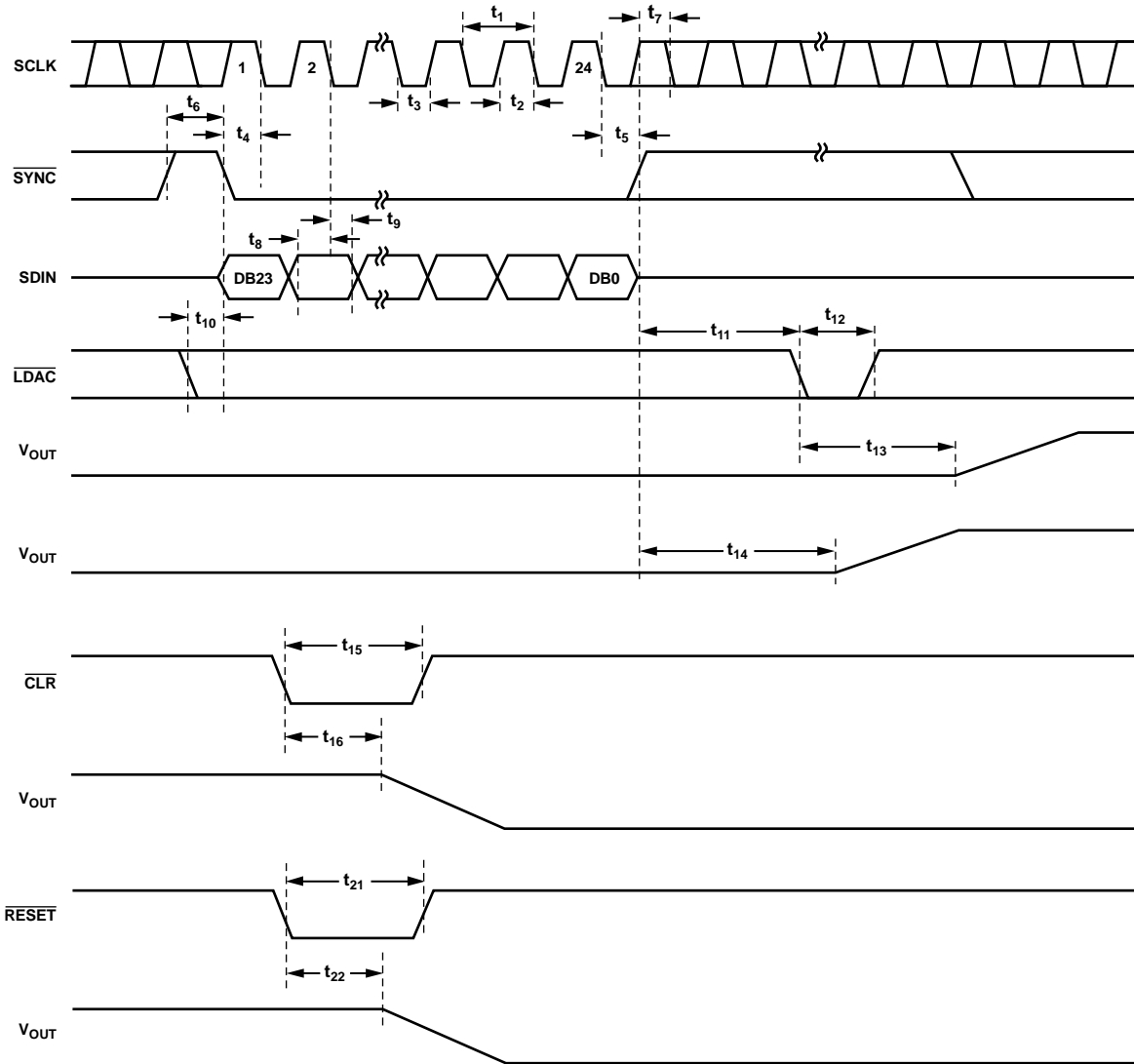

10455-002

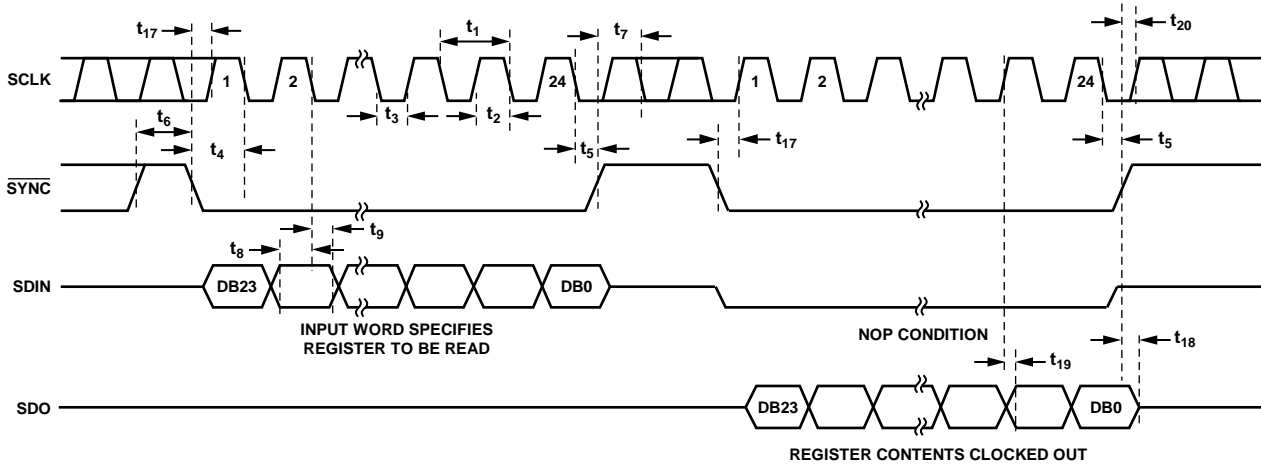

10455-003

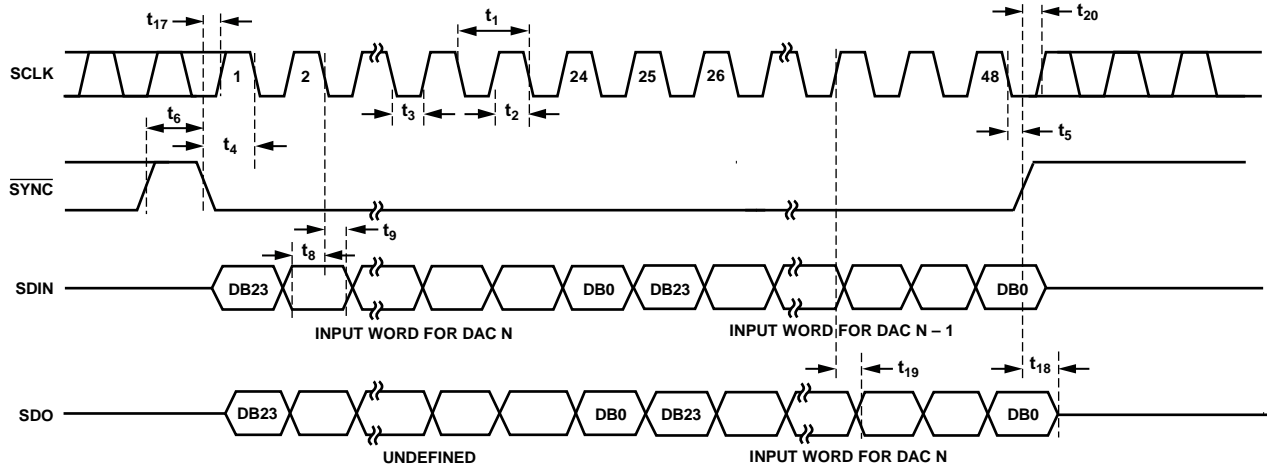

Figure 4. Daisy-Chain Mode Timing Diagram

10455-004

ABSOLUTE MAXIMUM RATINGS

$T_A = 25^\circ\text{C}$, unless otherwise noted. Transient currents of up to 100 mA do not cause SCR latch-up.

Table 4.

Parameter	Rating
V_{DD} to AGND	-0.3 V to +34 V
V_{SS} to AGND	-34 V to +0.3 V
V_{DD} to V_{SS}	-0.3 V to +34 V
V_{CC} to DGND	-0.3 V to +7 V
IOV_{CC} to DGND	-0.3 V to $V_{CC} + 0.3$ V or +7 V (whichever is less)
Digital Inputs to DGND	-0.3 V to $IOV_{CC} + 0.3$ V or +7 V (whichever is less)
V_{OUT} to AGND	-0.3 V to $V_{DD} + 0.3$ V
V_{REFPF} to AGND	-0.3 V to $V_{DD} + 0.3$ V
V_{REFPS} to AGND	-0.3 V to $V_{DD} + 0.3$ V
V_{REFNF} to AGND	$V_{SS} - 0.3$ V to +0.3 V
V_{REFNS} to AGND	$V_{SS} - 0.3$ V to +0.3 V
DGND to AGND	-0.3 V to +0.3 V
Operating Temperature Range, T_A	
Industrial	-55°C to +125°C
Storage Temperature Range	-65°C to +150°C
Maximum Junction Temperature, $T_{J\max}$	150°C
Power Dissipation	$(T_{J\max} - T_A)/\theta_{JA}$
TSSOP Package	
θ_{JA} Thermal Impedance	143°C/W
θ_{JC} Thermal Impedance	45°C/W
Lead Temperature	JEDEC industry standard
Soldering	J-STD-020
ESD (Human Body Model)	1.5 kV

Stresses above those listed under Absolute Maximum Ratings may cause permanent damage to the device. This is a stress rating only; functional operation of the device at these or any other conditions above those indicated in the operational section of this specification is not implied. Exposure to absolute maximum rating conditions for extended periods may affect device reliability.

This device is a high performance integrated circuit with an ESD rating of 1.5 kV, and it is ESD sensitive. Proper precautions should be taken for handling and assembly.

ESD CAUTION



ESD (electrostatic discharge) sensitive device. Charged devices and circuit boards can discharge without detection. Although this product features patented or proprietary protection circuitry, damage may occur on devices subjected to high energy ESD. Therefore, proper ESD precautions should be taken to avoid performance degradation or loss of functionality.

PIN CONFIGURATION AND FUNCTION DESCRIPTIONS

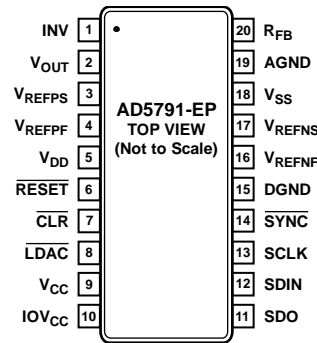

Figure 5. Pin Configuration

Table 5. Pin Function Descriptions

Pin No.	Mnemonic	Description
1	INV	Connection to Inverting Input of External Amplifier.
2	V _{OUT}	Analog Output Voltage.
3	V _{REFFPS}	Positive Reference Sense Voltage Input. A voltage range of 5 V to V _{DD} – 2.5 V can be connected. A unity gain amplifier must be connected at this pin in conjunction with the V _{REFFPF} pin.
4	V _{REFFPF}	Positive Reference Force Voltage Input. A voltage range of 5 V to V _{DD} – 2.5 V can be connected. A unity gain amplifier must be connected at this pin in conjunction with the V _{REFFPS} pin.
5	V _{DD}	Positive Analog Supply Connection. A voltage range of 7.5 V to 16.5 V can be connected; V _{DD} should be decoupled to AGND.
6	RESET	Active Low Reset Logic Input Pin. Asserting this pin returns the AD5791-EP to its power-on status.
7	CLR	Active Low Clear Logic Input Pin. Asserting this pin sets the DAC register to a user defined value and updates the DAC output. The output value depends on the DAC register coding that is being used, either binary or twos complement.
8	LDAC	Active Low Load DAC Logic Input Pin. This is used to update the DAC register and, consequently, the analog output. When tied permanently low, the output is updated on the rising edge of SYNC. If LDAC is held high during the write cycle, the input register is updated, but the output update is held off until the falling edge of LDAC. The LDAC pin should not be left unconnected.
9	V _{CC}	Digital Supply Connection. A voltage range of 2.7 V to 5.5 V can be connected. V _{CC} should be decoupled to DGND.
10	IOV _{CC}	Digital Interface Supply Pin. Digital threshold levels are referenced to the voltage applied to this pin. A voltage in the range of 1.71 V to 5.5 V can be connected. IOV _{CC} should not be allowed to exceed V _{CC} .
11	SDO	Serial Data Output Pin. Data is clocked out on the rising edge of the serial clock input.
12	SDIN	Serial Data Input Pin. This device has a 24-bit shift register. Data is clocked into the register on the falling edge of the serial clock input.
13	SCLK	Serial Clock Input. Data is clocked into the input shift register on the falling edge of the serial clock input. Data can be transferred at clock rates of up to 35 MHz.
14	SYNC	Active Low Digital Interface Synchronization Input Pin. This is the frame synchronization signal for the input data. When SYNC is low, it enables the input shift register, and data is then transferred in on the falling edges of the following clocks. The input shift register is updated on the rising edge of SYNC.
15	DGND	Ground Reference Pin for Digital Circuitry.
16	V _{REFNF}	Negative Reference Force Voltage Input. A voltage range of V _{SS} + 2.5 V to 0 V can be connected. A unity gain amplifier must be connected at this pin in conjunction with the V _{REFNS} pin.
17	V _{REFNS}	Negative Reference Sense Voltage Input. A voltage range of V _{SS} + 2.5 V to 0 V can be connected. A unity gain amplifier must be connected at this pin in conjunction with the V _{REFNF} pin.
18	V _{SS}	Negative Analog Supply Connection. A voltage range of –16.5 V to –2.5 V can be connected. V _{SS} should be decoupled to AGND.
19	AGND	Ground Reference Pin for Analog Circuitry.
20	R _{FB}	Feedback Connection for External Amplifier.

TYPICAL PERFORMANCE CHARACTERISTICS

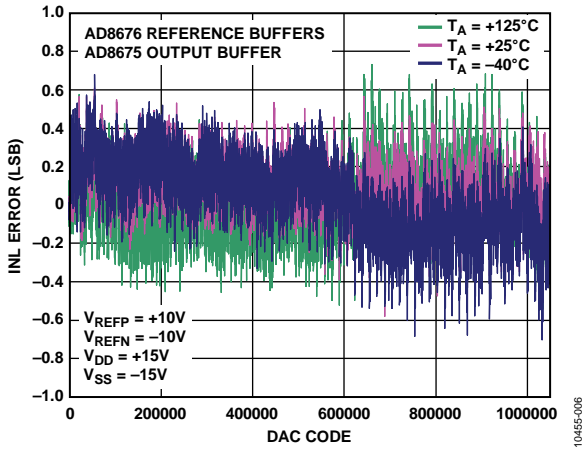

Figure 6. Integral Nonlinearity Error vs. DAC Code, ±10 V Span

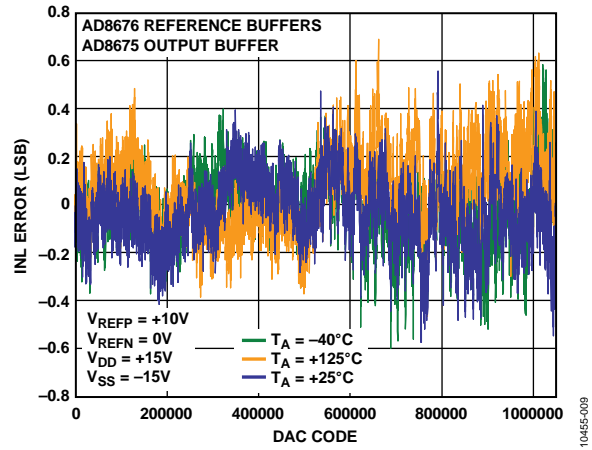

Figure 9. Integral Nonlinearity Error vs. DAC Code, ±10 V Span, ×2 Gain Mode

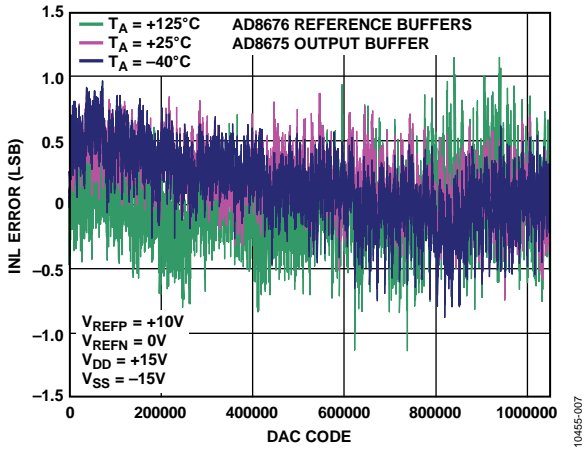

Figure 7. Integral Nonlinearity Error vs. DAC Code, 10 V Span

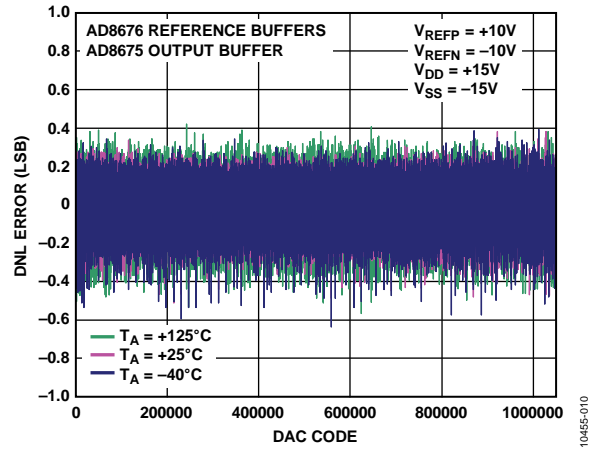

Figure 10. Differential Nonlinearity Error vs. DAC Code, ±10 V Span

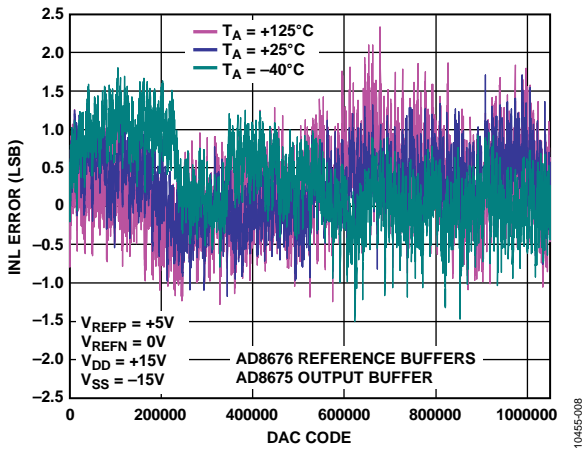

Figure 8. Integral Nonlinearity Error vs. DAC Code, 5 V Span

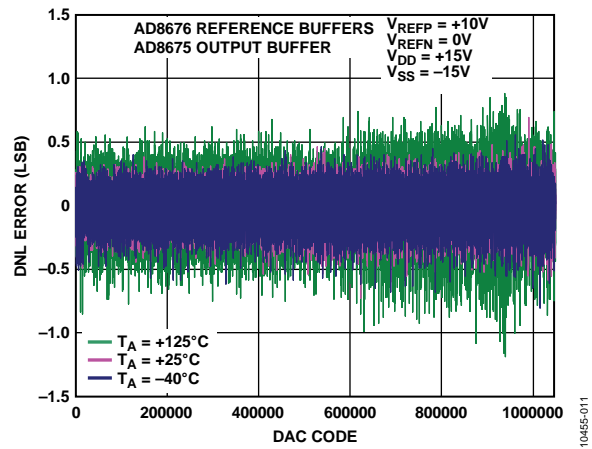

Figure 11. Differential Nonlinearity Error vs. DAC Code, 10 V Span

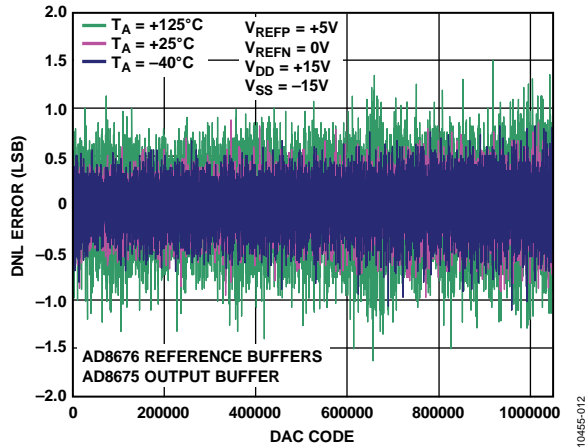

Figure 12. Differential Nonlinearity Error vs. DAC Code, 5 V Span

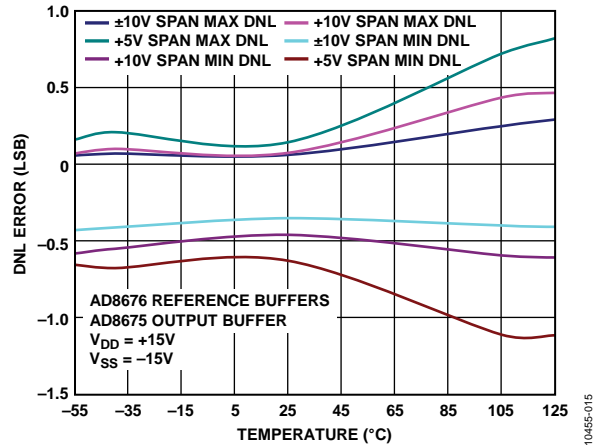

Figure 15. Differential Nonlinearity Error vs. Temperature

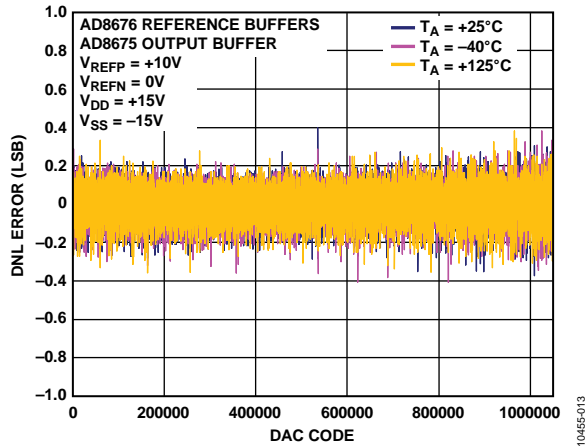

Figure 13. Differential Nonlinearity Error vs. DAC Code, ±10 V Span, x2 Gain Mode

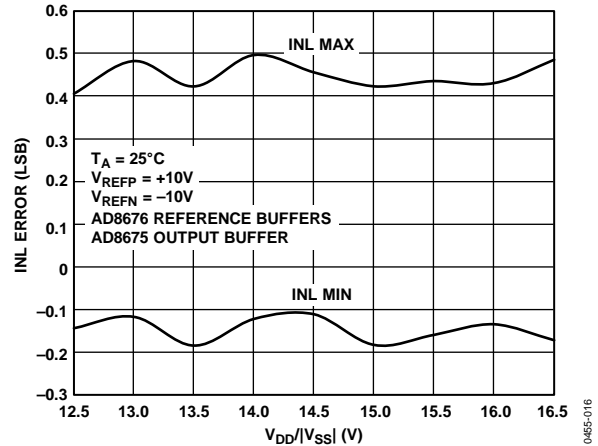

Figure 16. Integral Nonlinearity Error vs. Supply Voltage, ±10 V Span

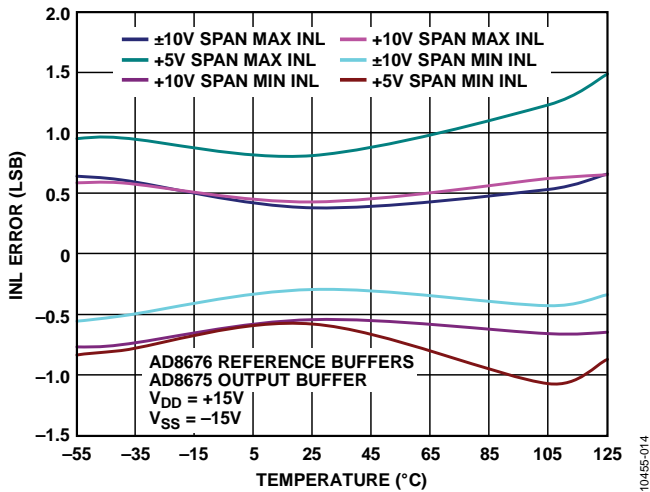

Figure 14. Integral Nonlinearity Error vs. Temperature

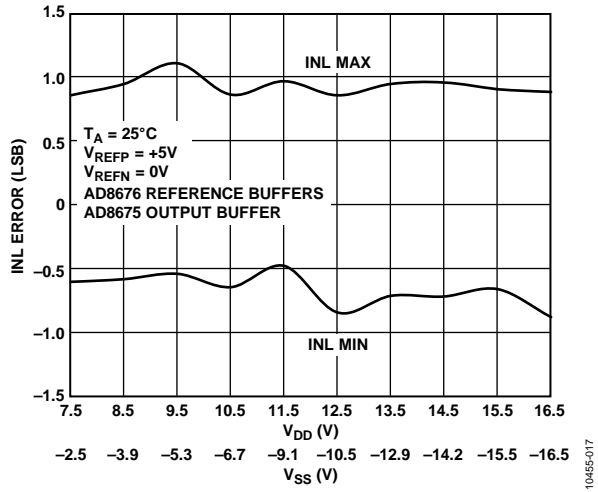

Figure 17. Integral Nonlinearity Error vs. Supply Voltage, 5 V Span

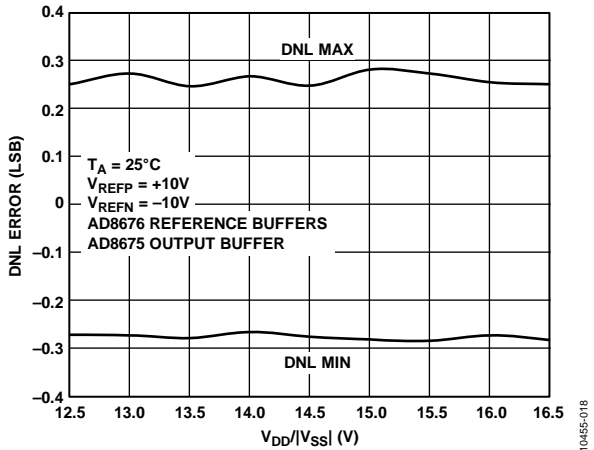

Figure 18. Differential Nonlinearity Error vs. Supply Voltage, ±10 V Span

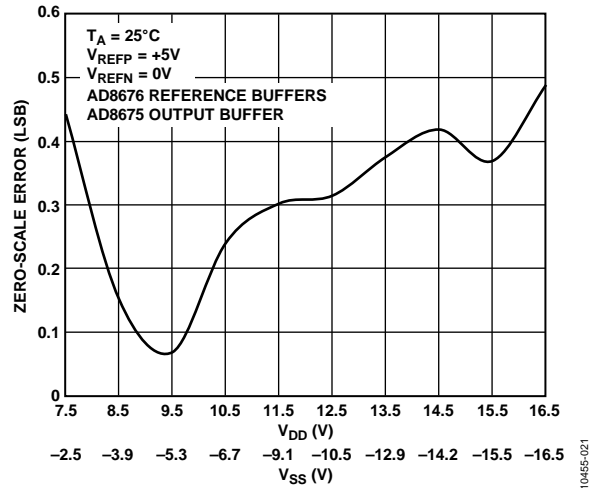

Figure 21. Zero-Scale Error vs. Supply Voltage, 5 V Span

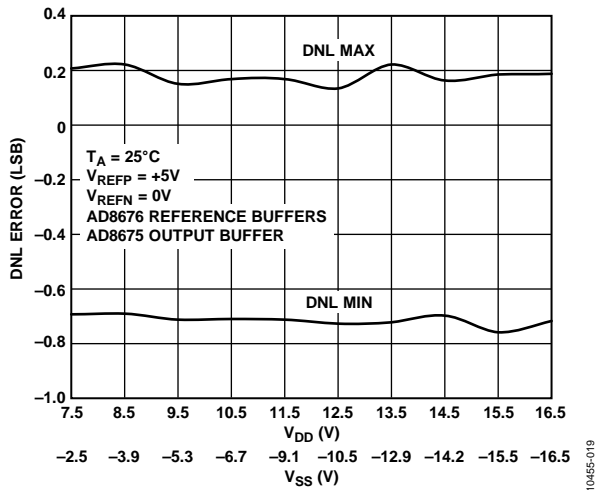

Figure 19. Differential Nonlinearity Error vs. Supply Voltage, 5 V Span

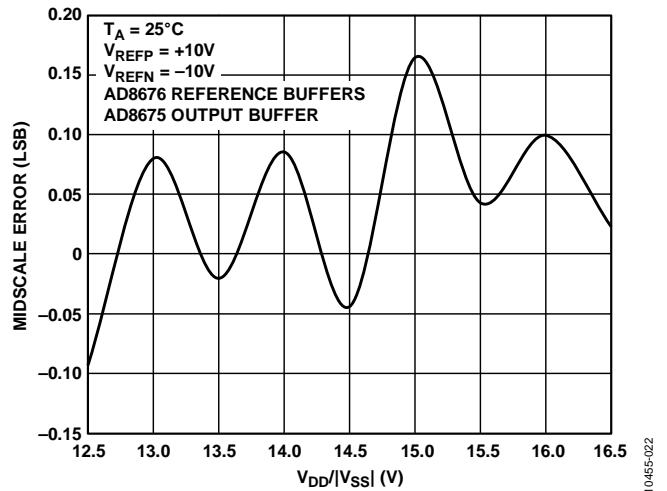

Figure 22. Midscale Error vs. Supply Voltage, ±10 V Span

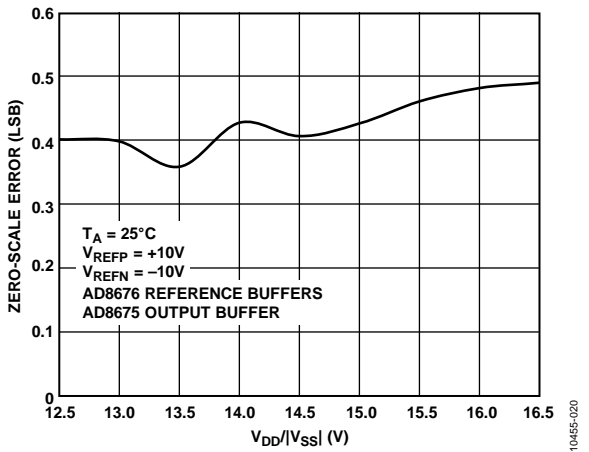

Figure 20. Zero-Scale Error vs. Supply Voltage, ±10 V Span

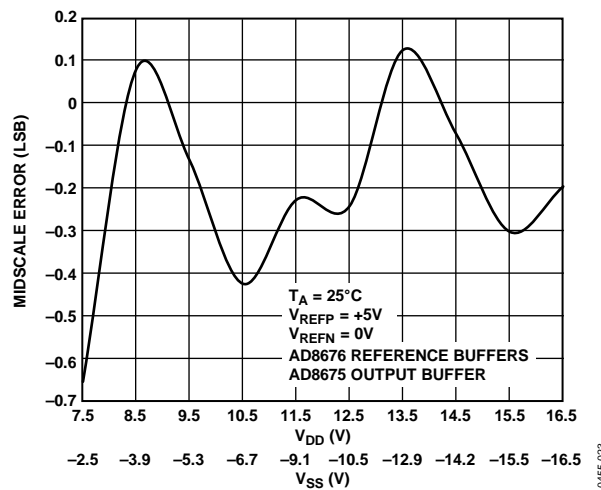

Figure 23. Midscale Error vs. Supply Voltage, 5 V Span

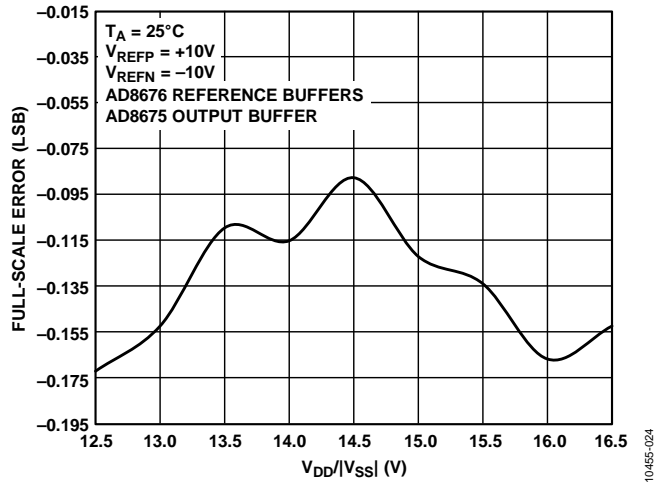

Figure 24. Full-Scale Error vs. Supply Voltage, ± 10 V Span

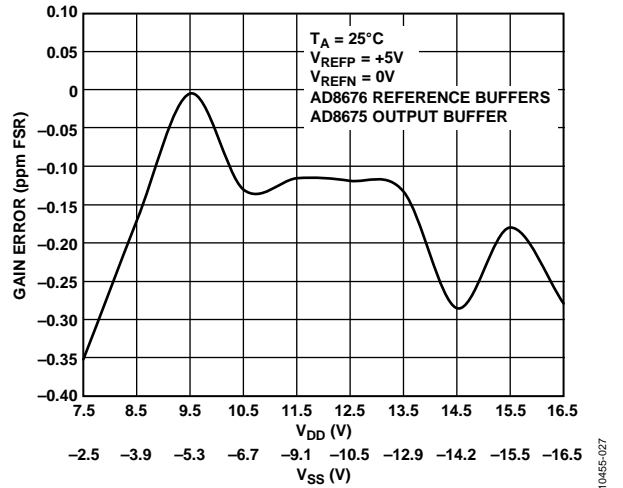

Figure 27. Gain Error vs. Supply Voltage, 5 V Span

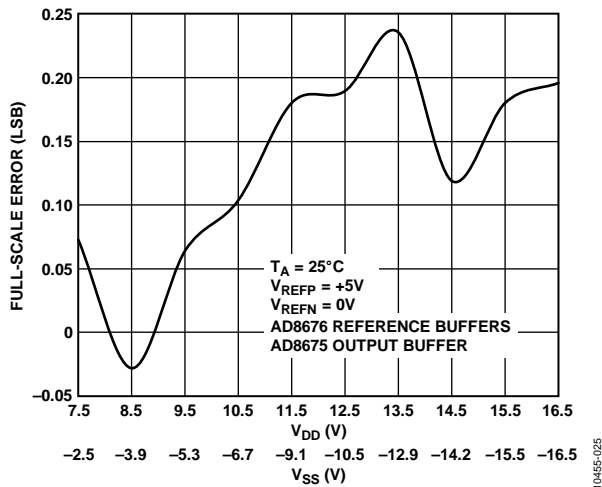

Figure 25. Full-Scale Error vs. Supply Voltage, 5 V Span

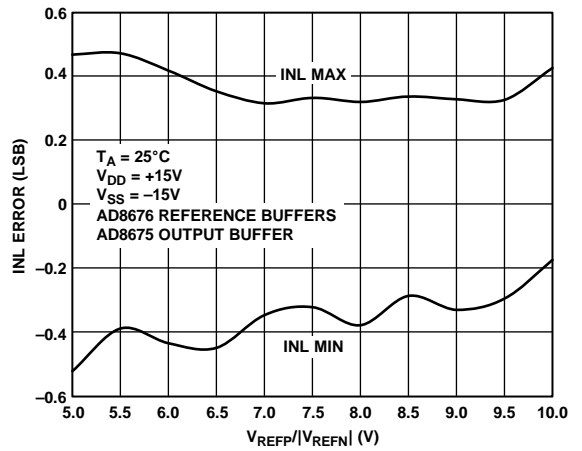

Figure 28. Integral Nonlinearity Error vs. Reference Voltage

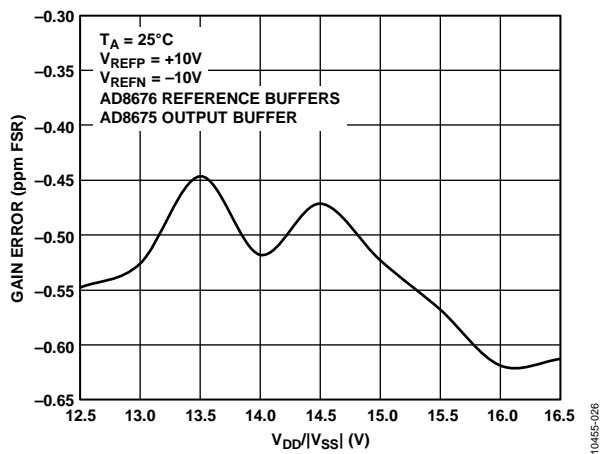

Figure 26. Gain Error vs. Supply Voltage, ± 10 V Span

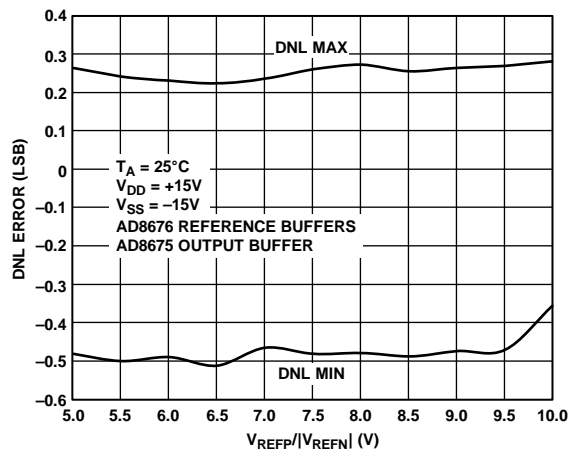

Figure 29. Differential Nonlinearity Error vs. Reference Voltage

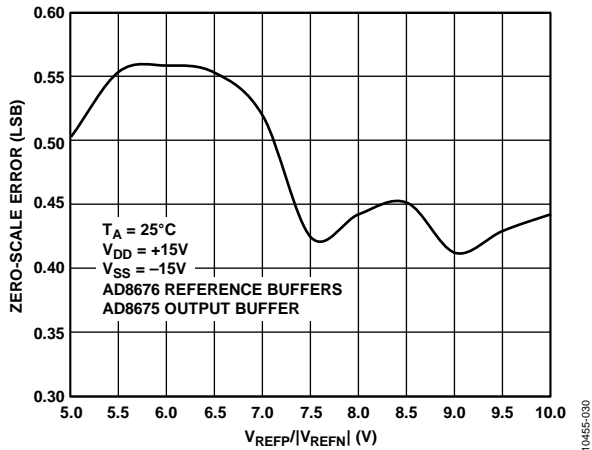

Figure 30. Zero-Scale Error vs. Reference Voltage

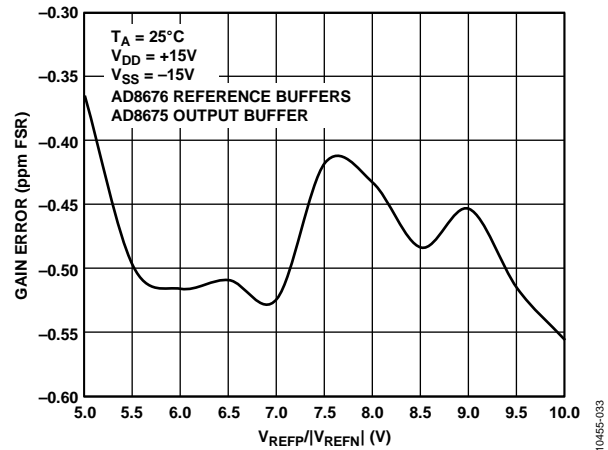

Figure 33. Gain Error vs. Reference Voltage

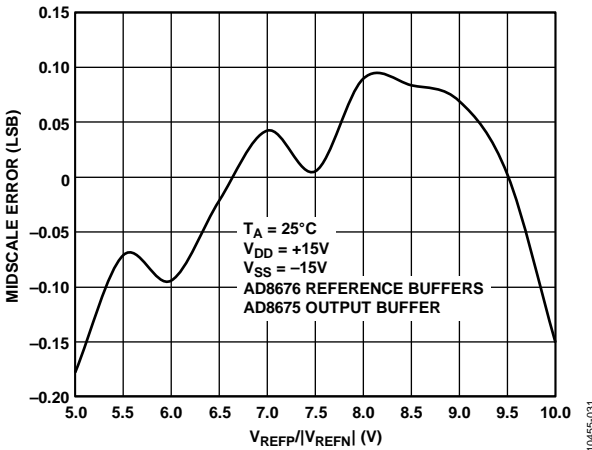

Figure 31. Midscale Error vs. Reference Voltage

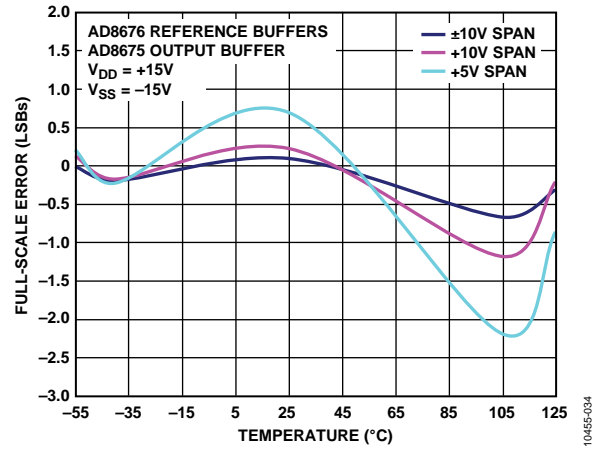

Figure 34. Full-Scale Error vs. Temperature

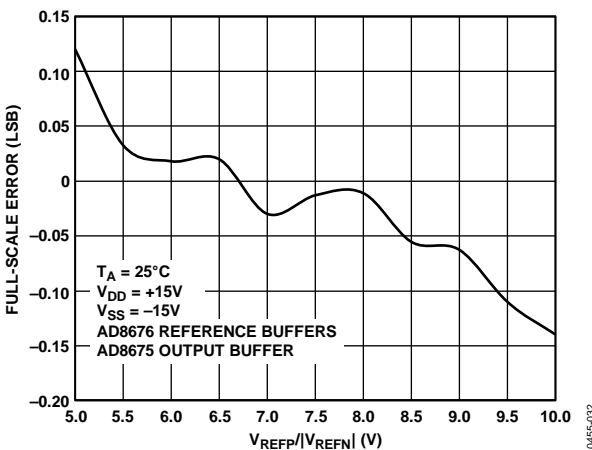

Figure 32. Full-Scale Error vs. Reference Voltage

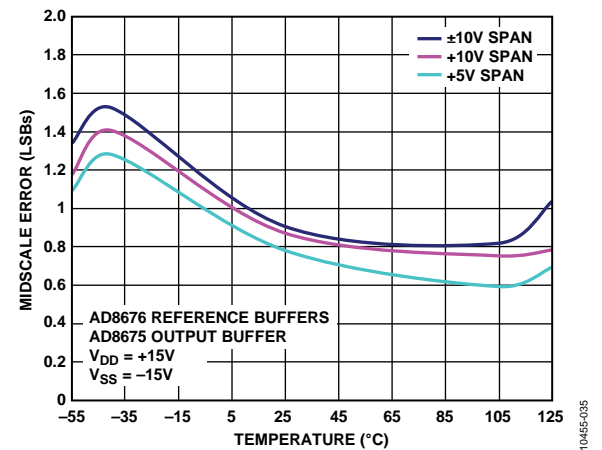

Figure 35. Midscale Error vs. Temperature

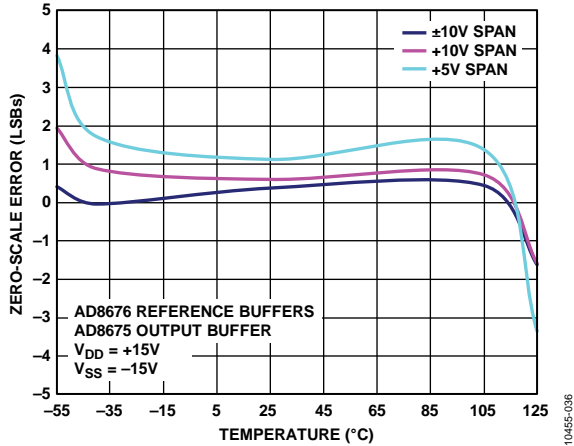

Figure 36. Zero-Scale Error vs. Temperature

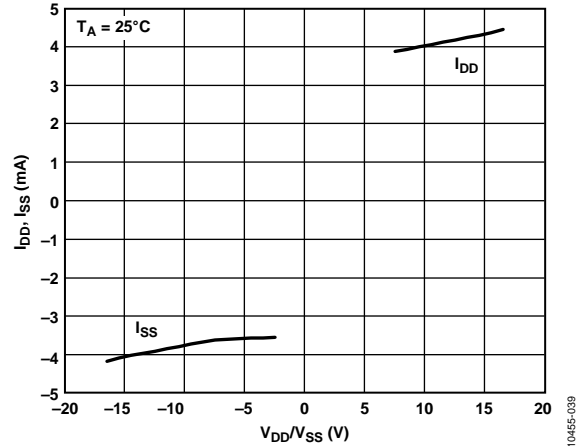

Figure 39. Power Supply Currents vs. Power Supply Voltages

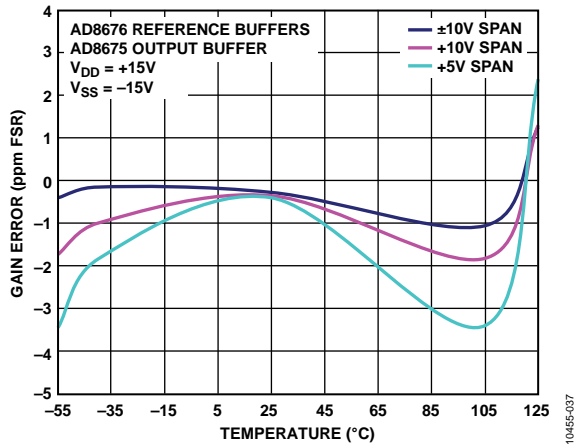

Figure 37. Gain Error vs. Temperature

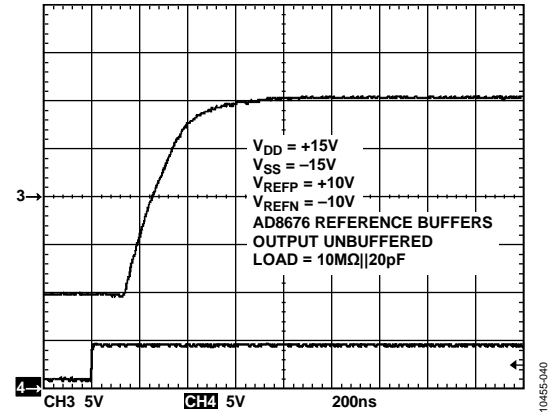

Figure 40. Rising Full-Scale Voltage Step

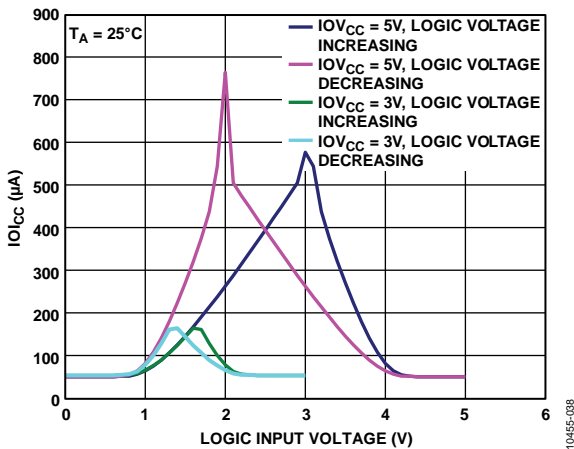

Figure 38. I_{OCC} vs. Logic Input Voltage

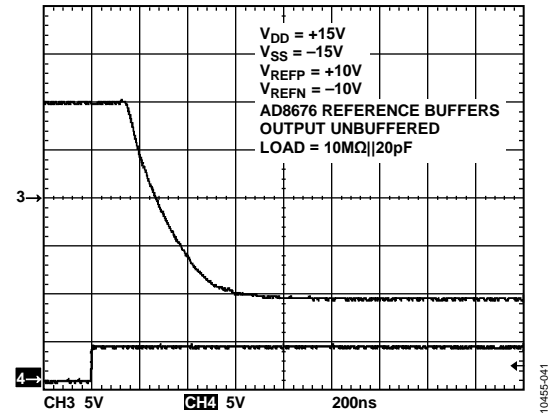

Figure 41. Falling Full-Scale Voltage Step

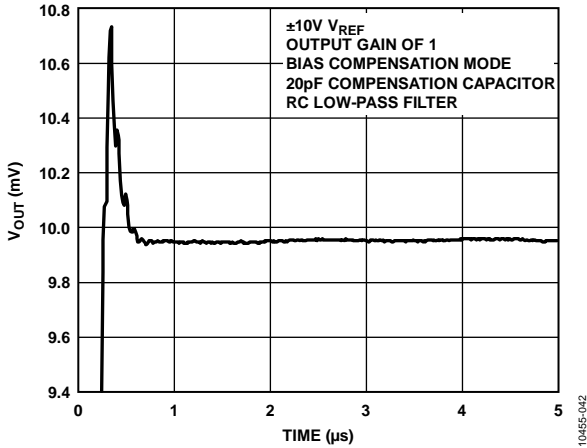

Figure 42. 500 Code Step Settling Time

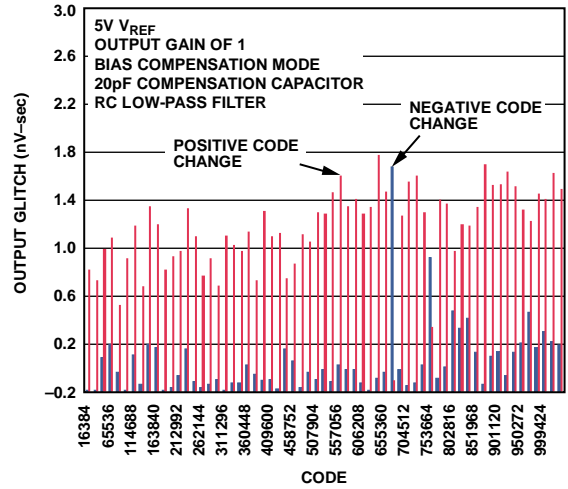

Figure 45. 6 MSB Segment Glitch Energy for +5 V VREF

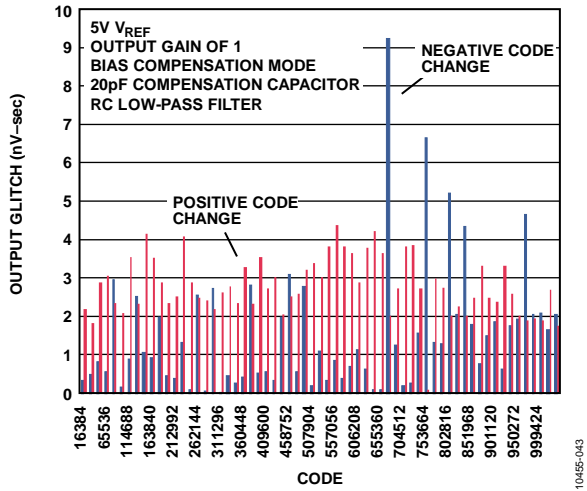

Figure 43. 6 MSB Segment Glitch Energy for ±10 V VREF

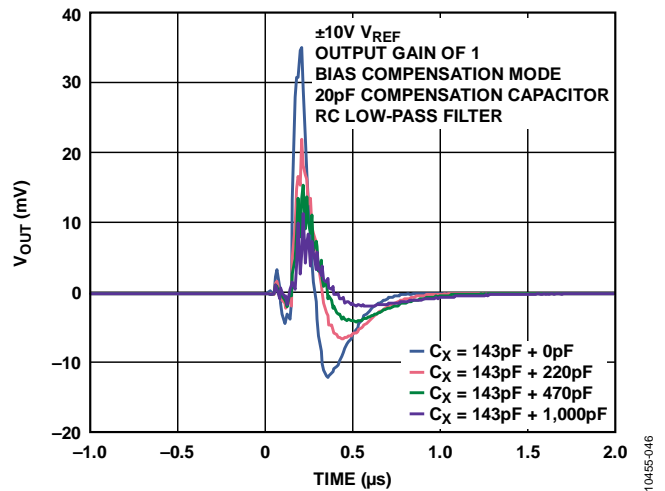

Figure 46. Midscale Peak-to-Peak Glitch for ±10 V

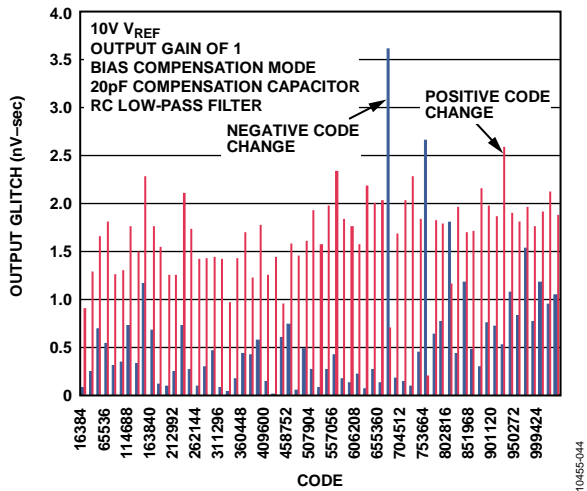

Figure 44. 6 MSB Segment Glitch Energy for +10 V VREF

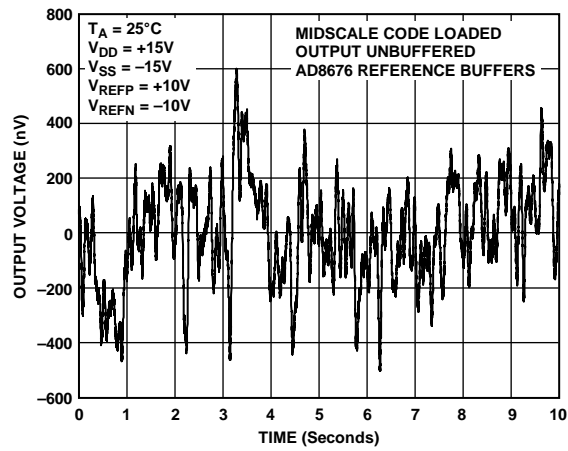

Figure 47. Voltage Output Noise, 0.1 Hz to 10 Hz Bandwidth

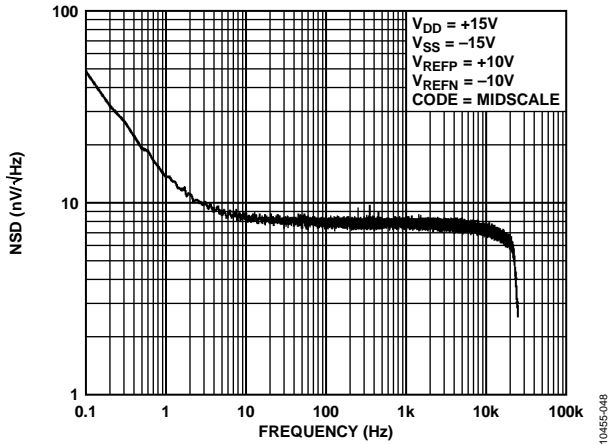

Figure 48. Noise Spectral Density vs. Frequency

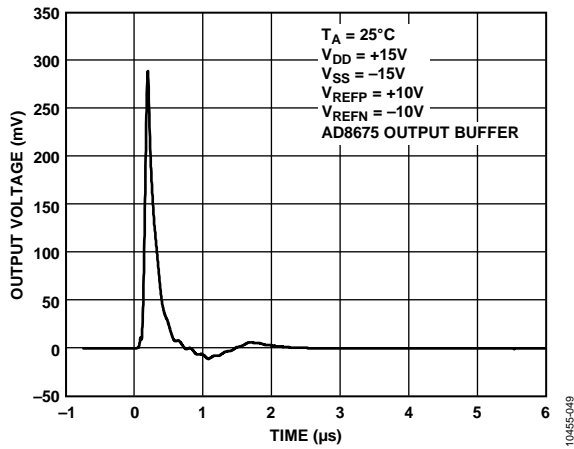
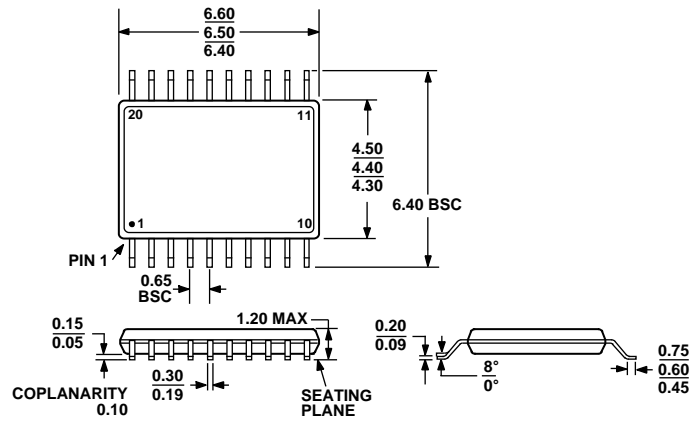

Figure 49. Glitch Impulse on Removal of Output Clamp

OUTLINE DIMENSIONS



COMPLIANT TO JEDEC STANDARDS MO-153-AC

Figure 50. 20-Lead Thin Shrink Small Outline Package [TSSOP] (RU-20)

Dimensions shown in millimeters

ORDERING GUIDE

Model	Temperature Range	INL	Package Description	Package Option
AD5791SRU-EP	-55°C to +125°C	±1.5 LSB	20-Lead TSSOP	RU-20

NOTES

NOTES